

**High Current Module  $\phi 7.7\text{mm}/0.303''$  2pin  
UJC Series**

$\phi 7.7\text{mm}/0.303''$  module  
Current rating : 80A at 25°C

Insulator P/N  
**UJC-M77X2-T250**

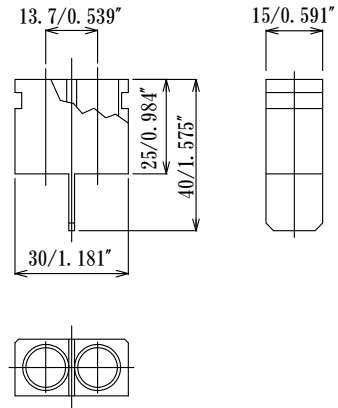

Dielectric strength : 1000V

Please call factory about followings  
Crimping tool  
Pin Removal tool

Socket pin P/N

Plug pin P/N

Crimping

Crimping



**UJCS77-367F72LG-CR**

**UJCP77-525F8LG-CR**

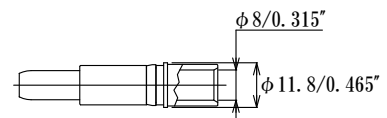
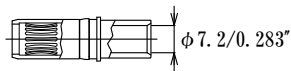

**UJCS77-367F6LG-CR**

**UJCP77-525F72LG-CR \***

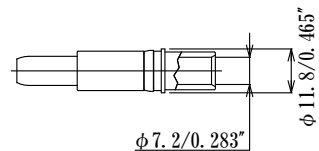
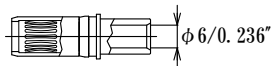

**UJCP77-525F6LG-CR**

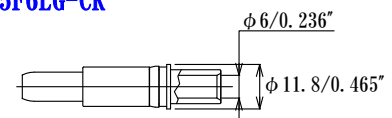

Gold plating

Gold plating

\* mark product is made only upon order.

**High Current Module  $\phi 8.0\text{mm}/0.315''$   
UJC Series**

$\phi 8.0\text{mm}/0.315''$  connector  
Current rating : 100A at 25°C

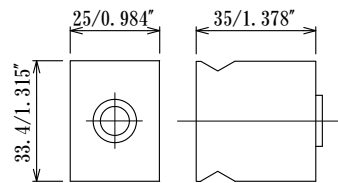

Insulator set P/N:  
**UJC-M80X1-T350**  
**UJC-M80X1-T050**

Dielectric strength : 5000V

(Since two insulators are used together, please order both.)

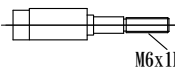
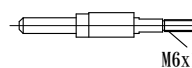
Pin type	Socket pin P/N	Plug pin P/N
Thread	<b>UJCS80X2LV-71LG</b> 	<b>UJCP80-290LG</b> 

Example of combination

